

CREATE
YOUR STYLE
with SWAROVSKI ELEMENTS

WEDDING PRINCESS ORCHID CUFF

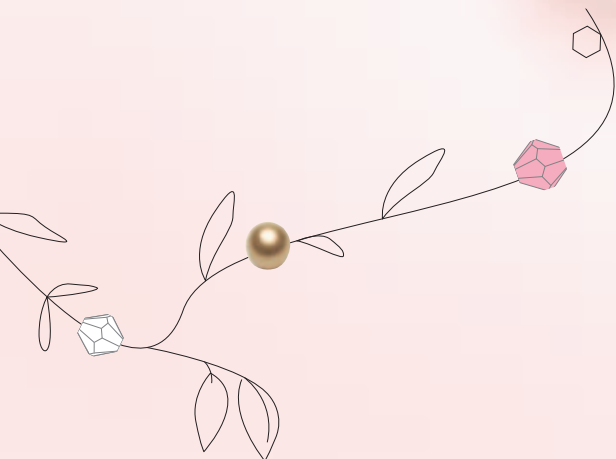

WEDDING PRINCESS ORCHID CUFF



SWAROVSKI ELEMENTS

Article	Product Group	Article No.	Amount	Size	Color	Color Code
	Beads	5000	2 pcs.	8 mm	Crystal Silver Shade	001 SSHA
	Beads	5328	9 pcs.	3 mm	Crystal CAL	001 CAL
	Beads	5328	85 pcs.	4 mm	Crystal CAL	001 CAL
	Beads	5328	14 pcs.	4 mm	Crystal Silver Shade	001 SSHA
	Beads	5621	3 pcs.	18 mm	Crystal Silver Shade	001 SSHA
	Beads	5621	6 pcs.	18 mm	Crystal Moonlight	001 MOL
	Beads	5621	3 pcs.	22 mm	Crystal Silver Shade	001 SSHA
	Pendants	6656	3 pcs.	19 mm	Crystal Silver Shade	001 SSHA

Supplies & Tools

- Supplies**
- 3 x Head pin, silver, Ø0.64 mm
 - Wire, silver, Ø0.4 mm, 684 cm
 - Wire, silver, Ø1 mm, 61 cm
- Tools**
- Flat nose pliers
 - Round nose pliers
 - Wire cutter

Level of design: ADVANCED

STEP 1

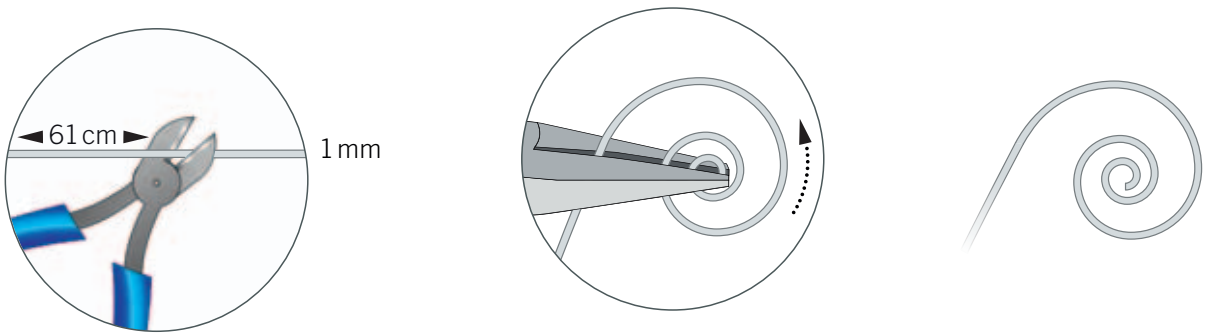

STEP 2

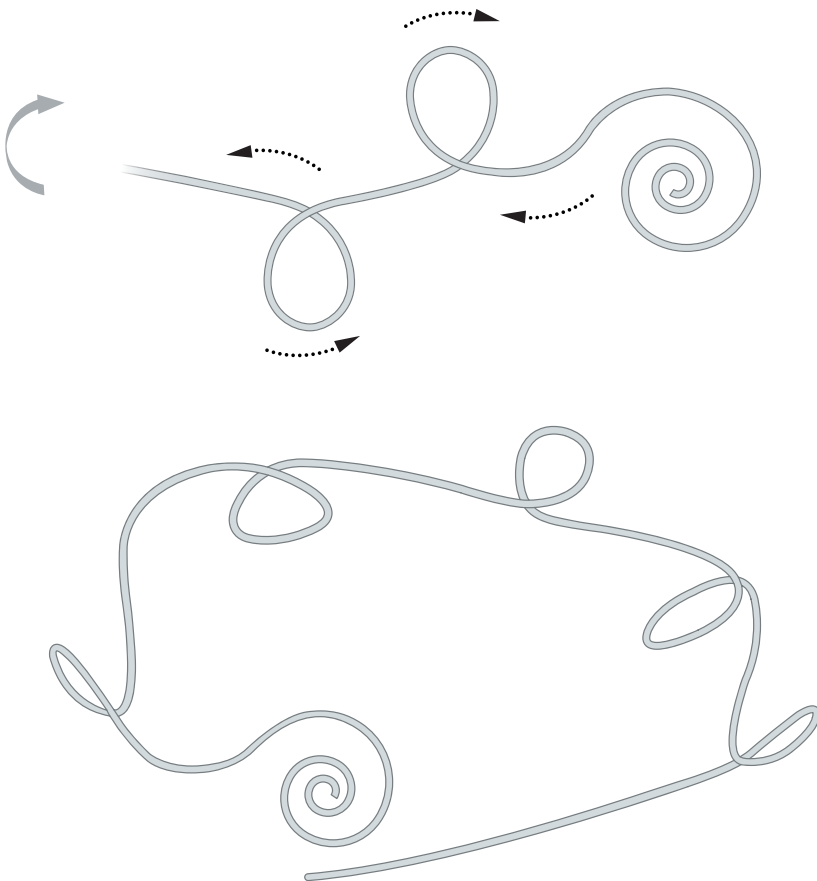

STEP 3

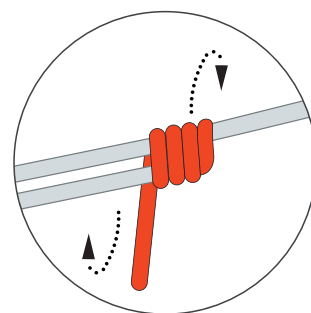
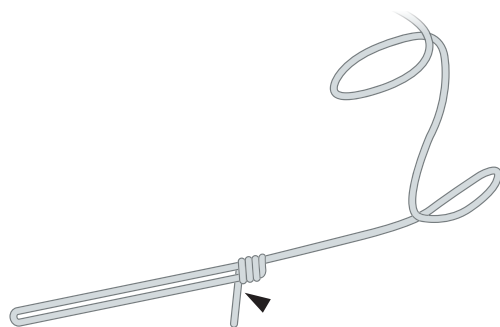
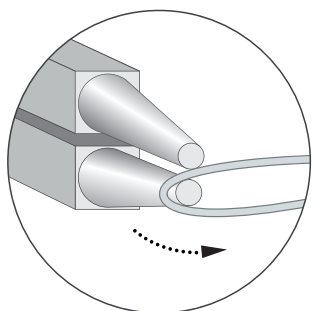

STEP 4

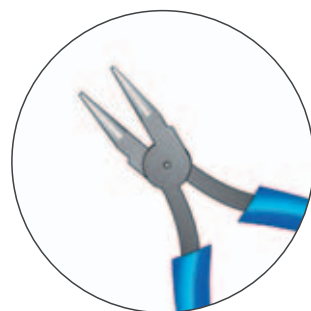
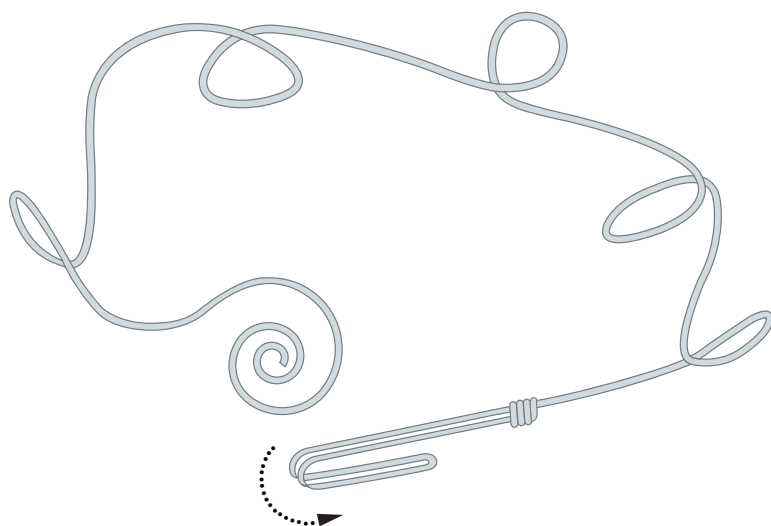

STEP 5

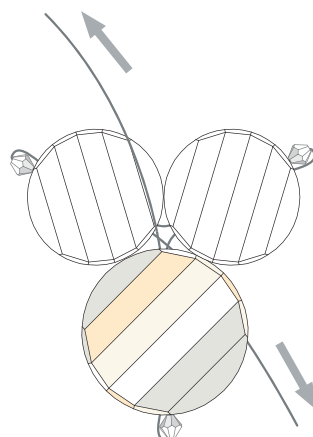
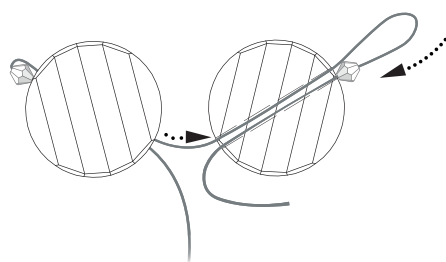
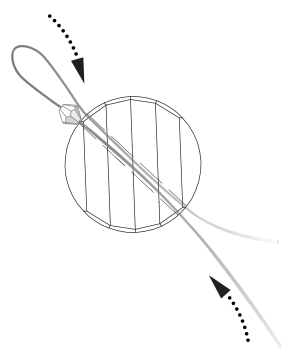
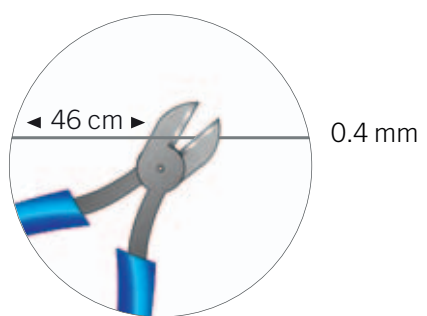

STEP 6

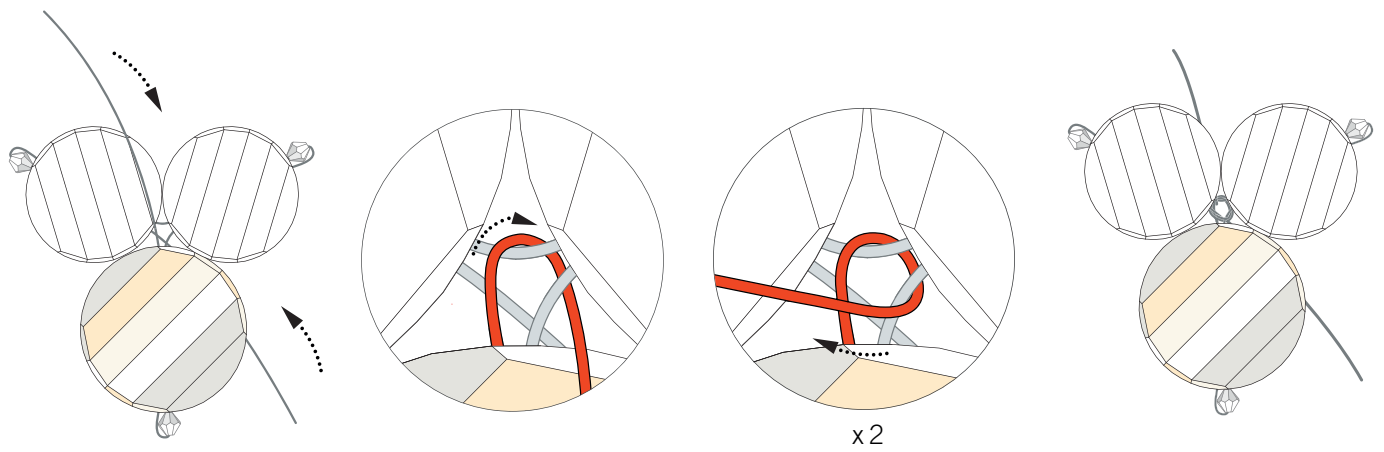

STEP 7

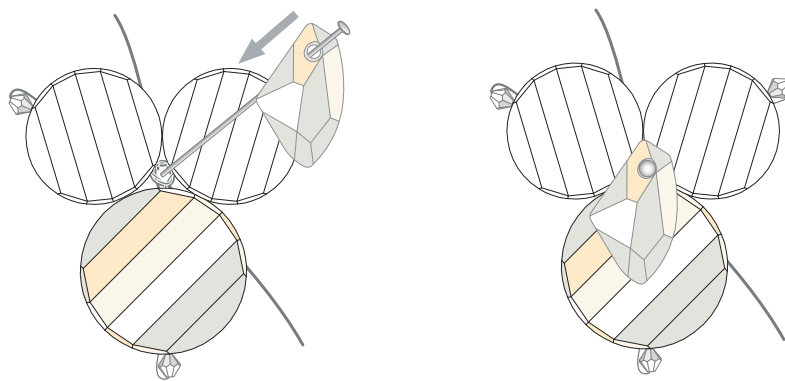

STEP 8

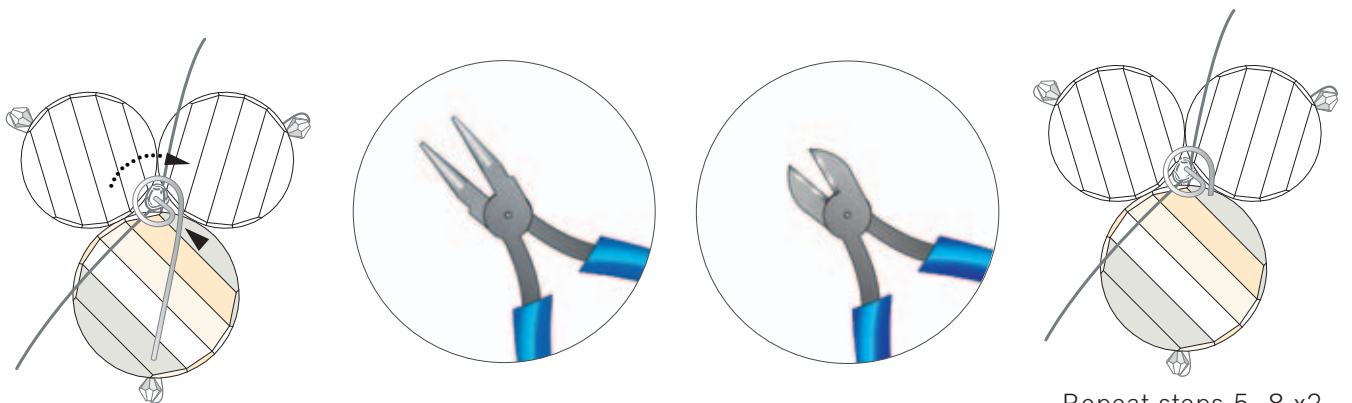

Repeat steps 5- 8 x2

STEP 9

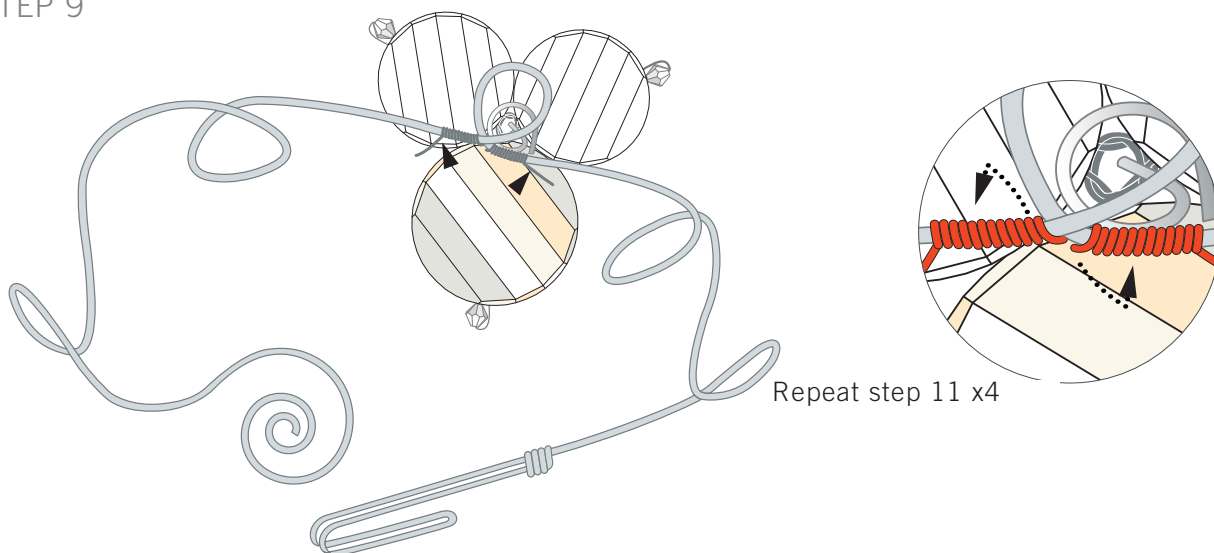

Repeat step 9 x2

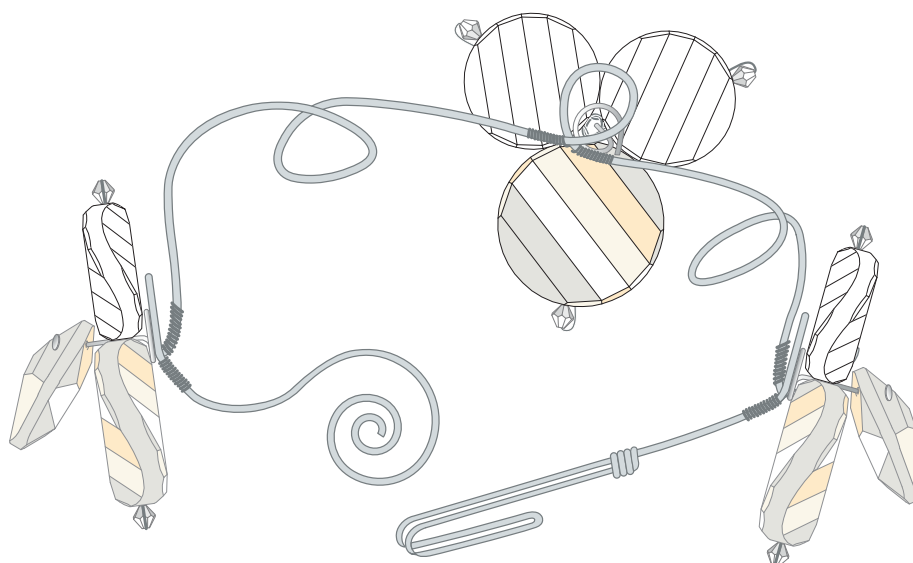

STEP 10

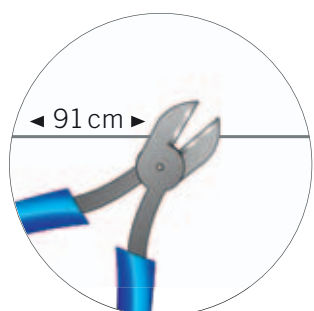

0.4 mm

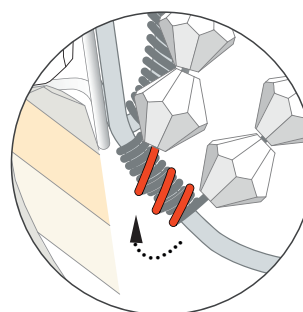
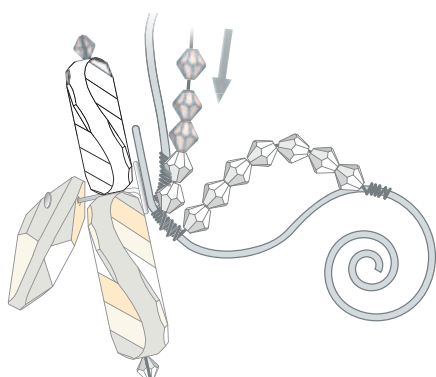
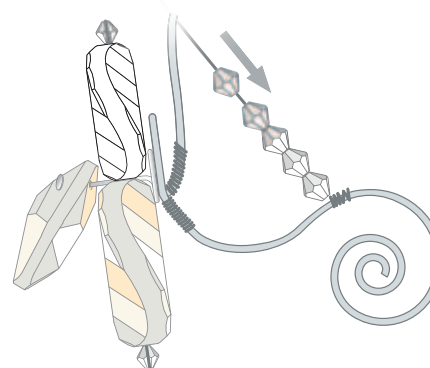
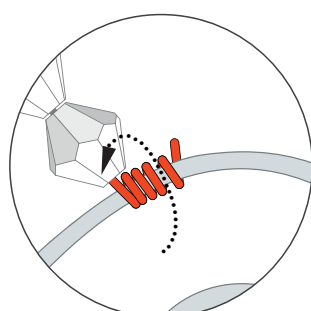

Repeat step 10 x4

STEP 11

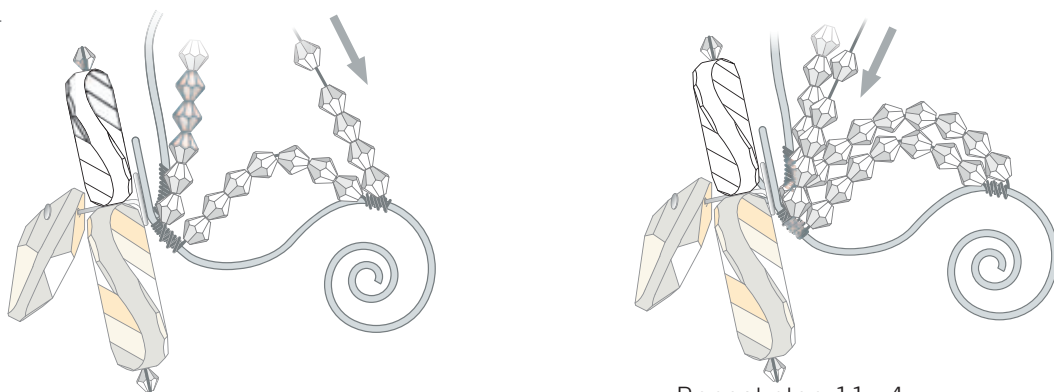

Repeat step 11 x4

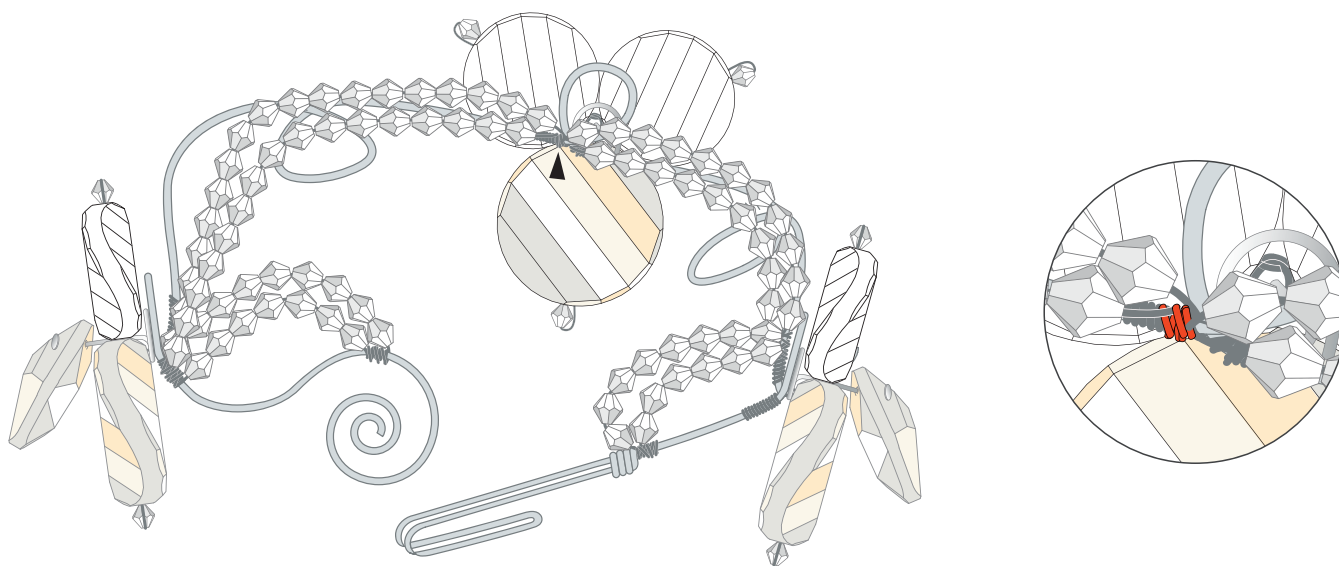

STEP 12

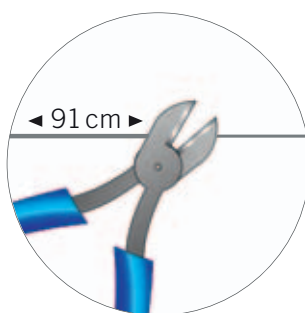

0.4 mm

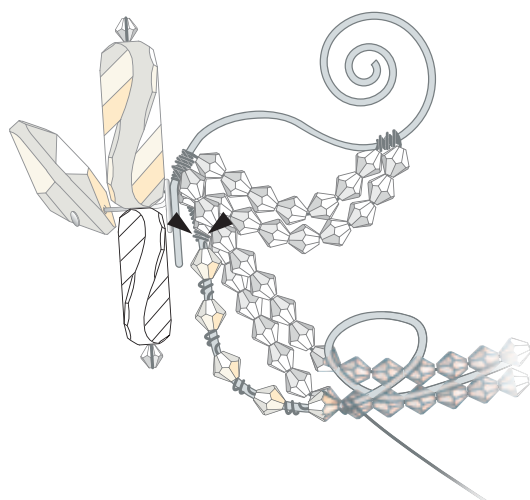
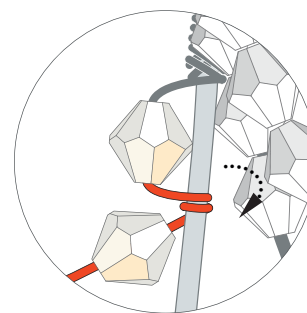
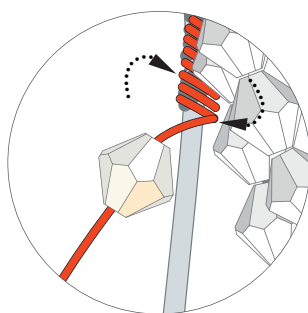

STEP 13

