

CREATE
YOUR STYLE
with SWAROVSKI ELEMENTS

WEDDING COUNTRY ALBUM



WEDDING COUNTRY ALBUM



SWAROVSKI ELEMENTS

Article	Product Group	Article No.	Amount	Size	Color	Color Code
	Beads	5328	28 pcs.	4 mm	Crystal AB	001 AB
	Beads	5328	20 pcs.	4 mm	Light Azore	361
	Beads	5328	24 pcs.	4 mm	Vintage Rose	319
	Beads	5328	3 pcs.	6 mm	Crystal AB	001 AB
	Beads	5754	7 pcs.	10 mm	Crystal AB	001 AB
	Crystal Pearls	5810	28 pcs.	3 mm	Crystal Rosaline Pearl	001 620
	Crystal Pearls	5810	18 pcs.	4 mm	Crystal Cream Pearl	001 620
	Crystal Pearls	5810	6 pcs.	4 mm	Crystal Powder Rose Pearl	001 352
	Crystal Pearls	5810	18 pcs.	4 mm	Crystal Rosaline Pearl	001 294
	Crystal Pearls	5810	2 pcs.	8 mm	Crystal Cream Pearl	001 620
	Crystal Pearls	5810	2 pcs.	8 mm	Crystal Rosaline Pearl	001 620
	Crystal Pearls	5817	2 pcs.	12 mm	Crystal Cream Pearl	001 620

Supplies & Tools

- Supplies**
- Album with srew binding, DIN A4
 - Cotton yarn, green
 - 2x Linen textil, cream white, 47x 39cm
 - Nylon thread, Ø0.15 mm
 - Nylon thread, Ø0.25 mm
 - Sewing thread, cream white
 - Sewing thread, silver, 120 cm
- Tools**
- Beading needle
 - Crocheting hook ca. 2.5 mm
 - Glue
 - Iron
 - Needle
 - Scissors
 - Screw driver
 - Punch

Level of design: INTERMEDIATE

STEP 1

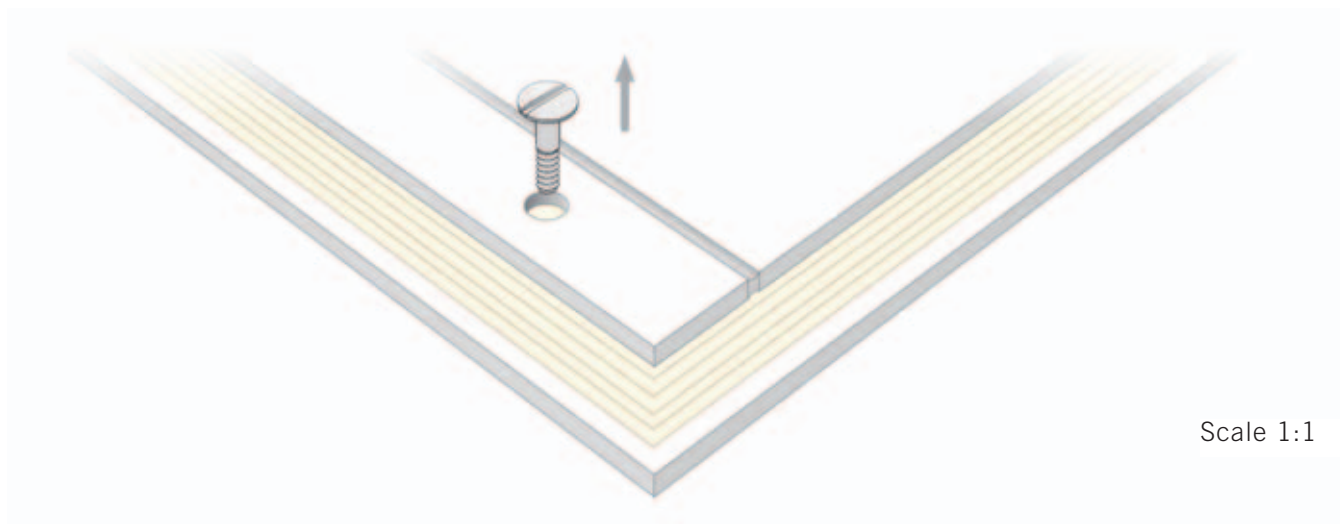

STEP 2

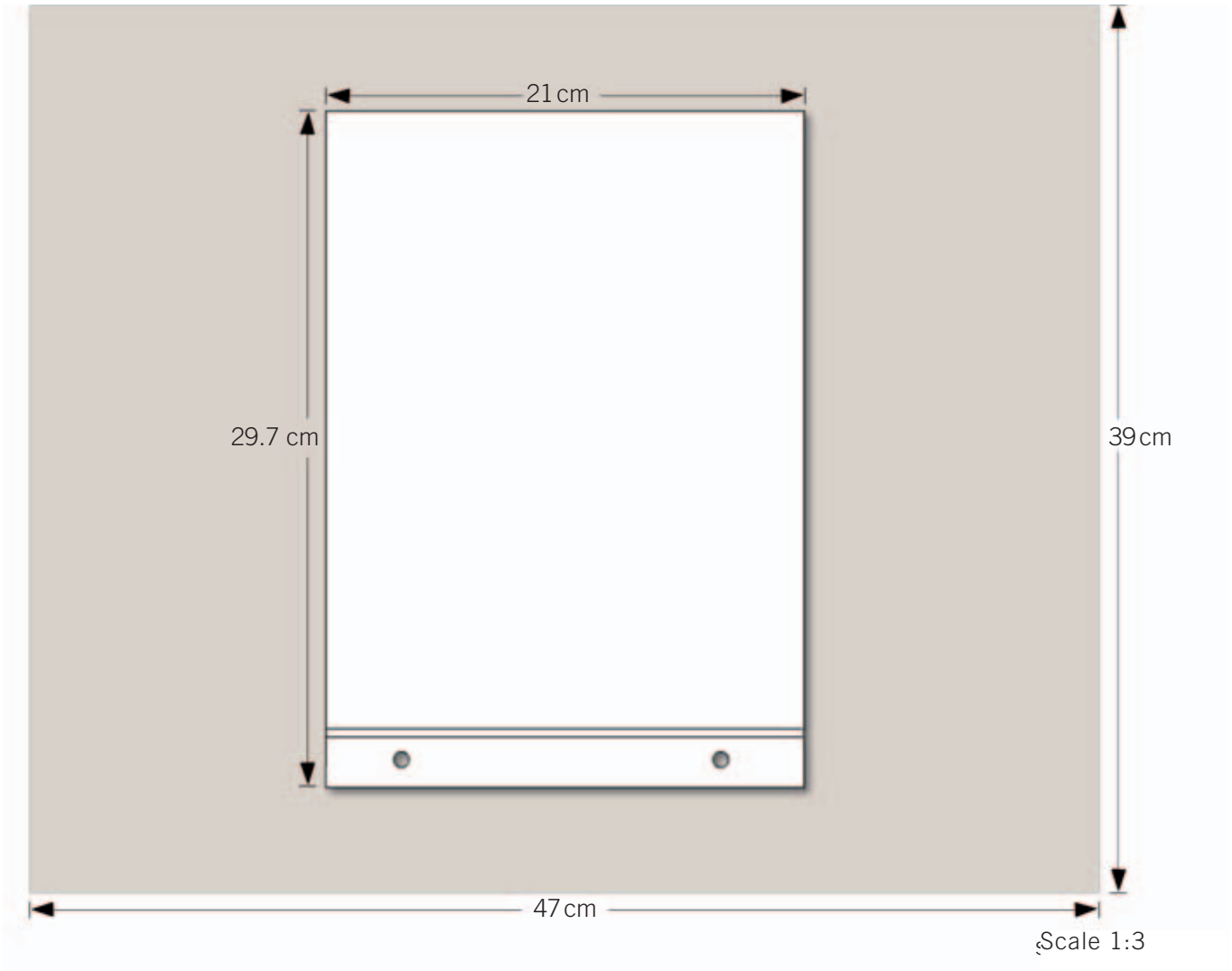

STEP 3



STEP 4

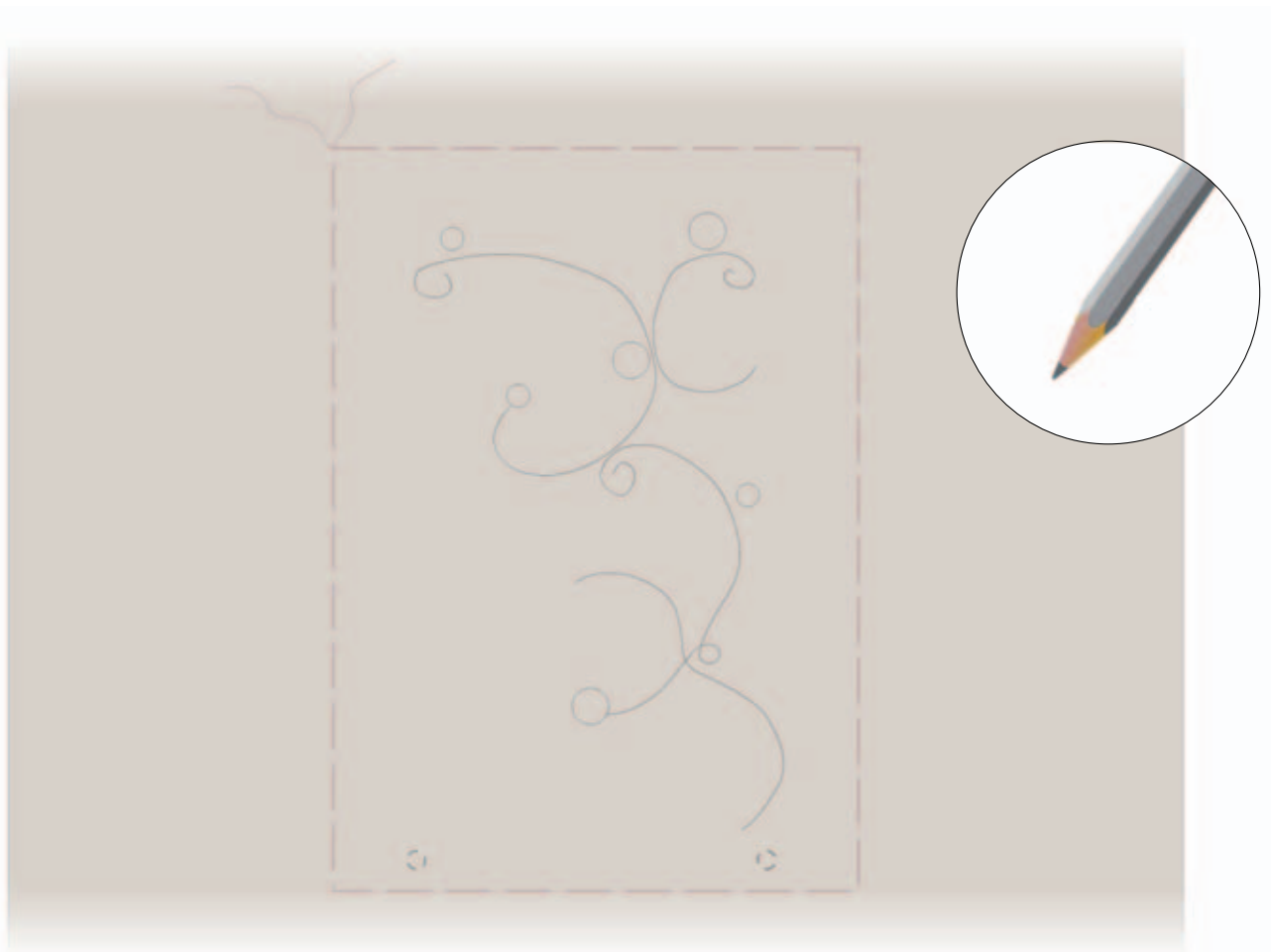

STEP 5



Scale 1:1

STEP 6

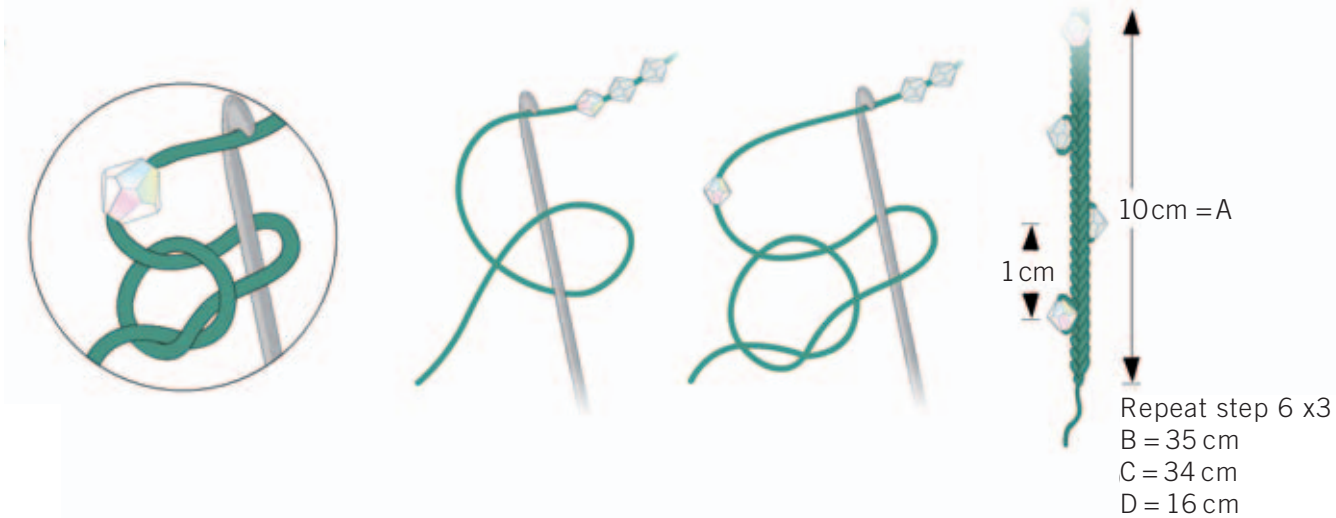

STEP 7

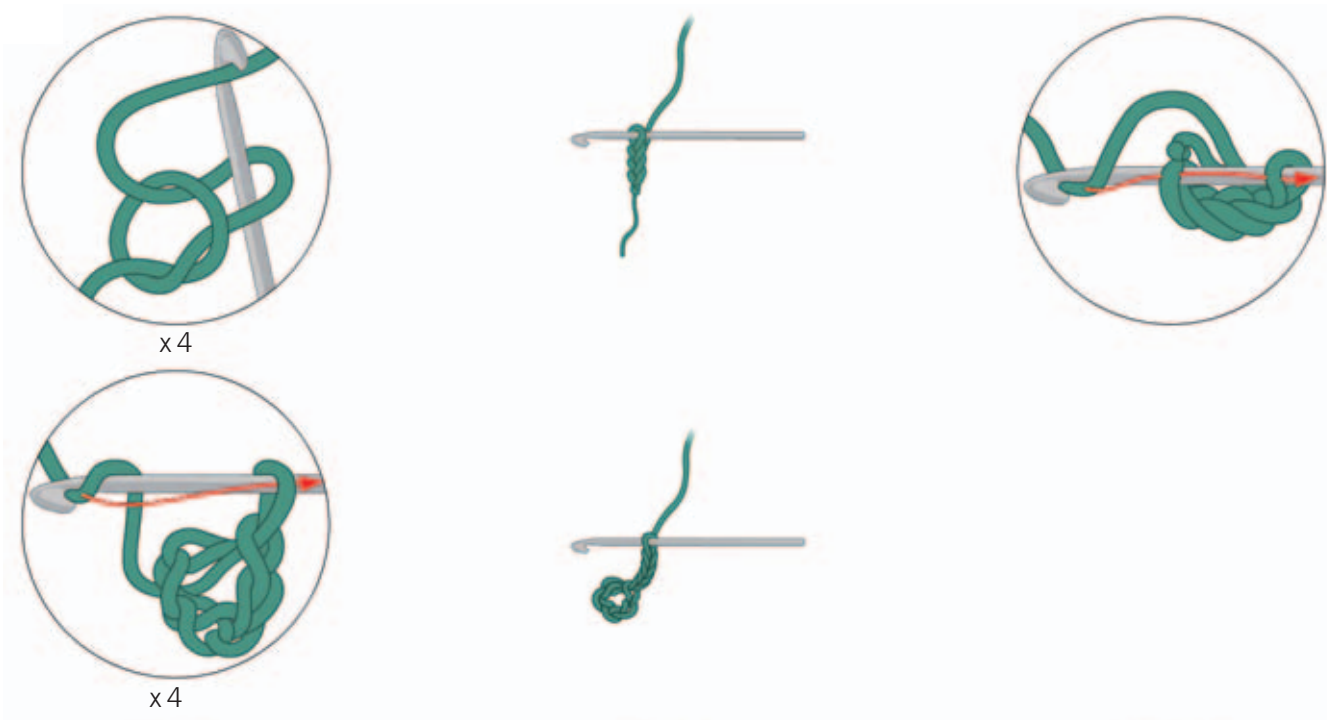

STEP 8

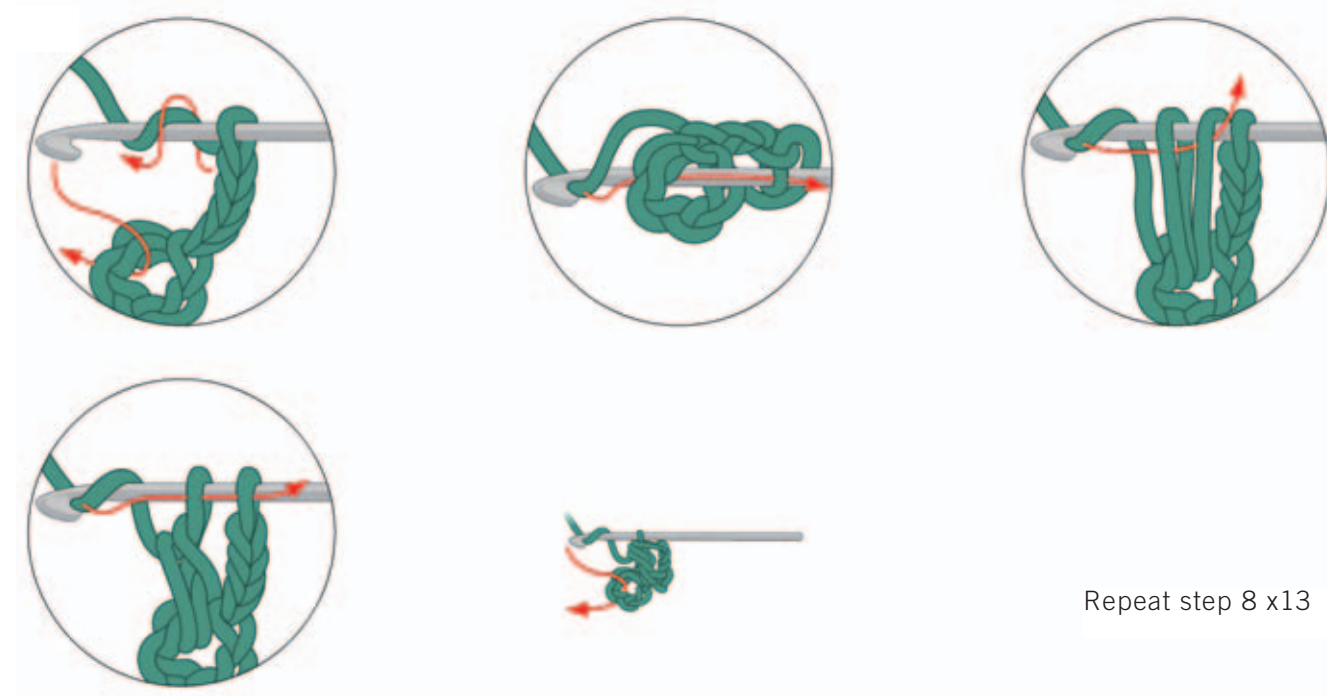

STEP 9

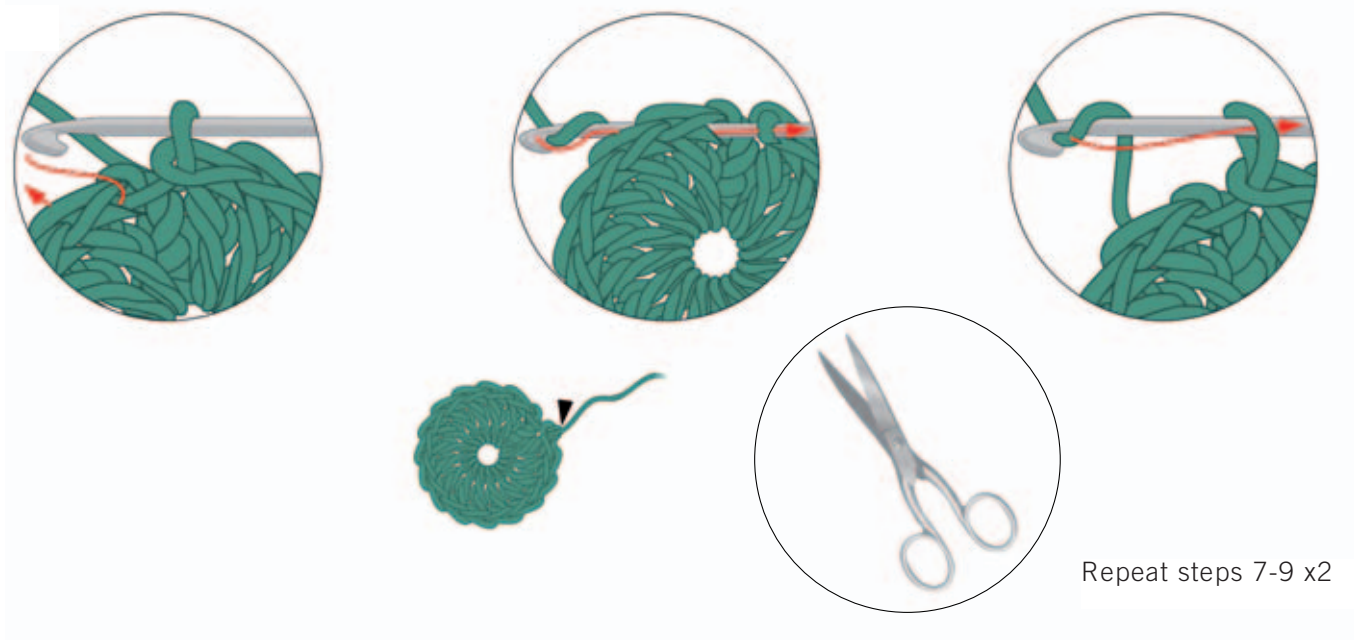

STEP 10

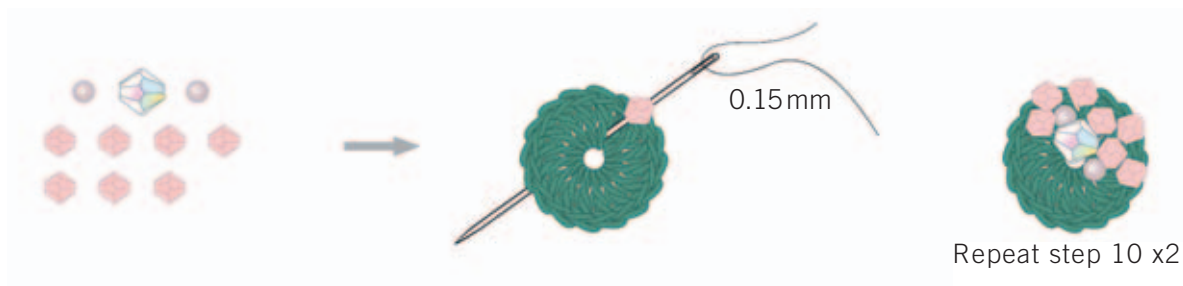

STEP 11

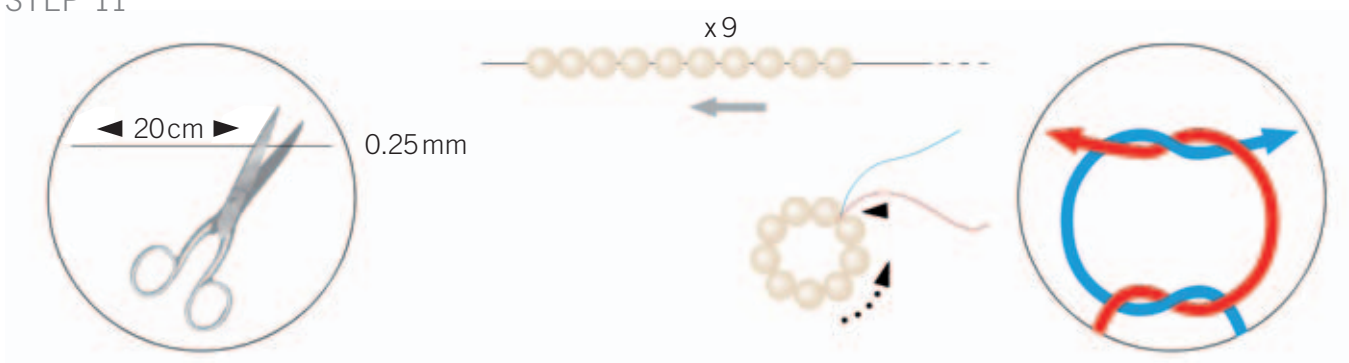

STEP 12

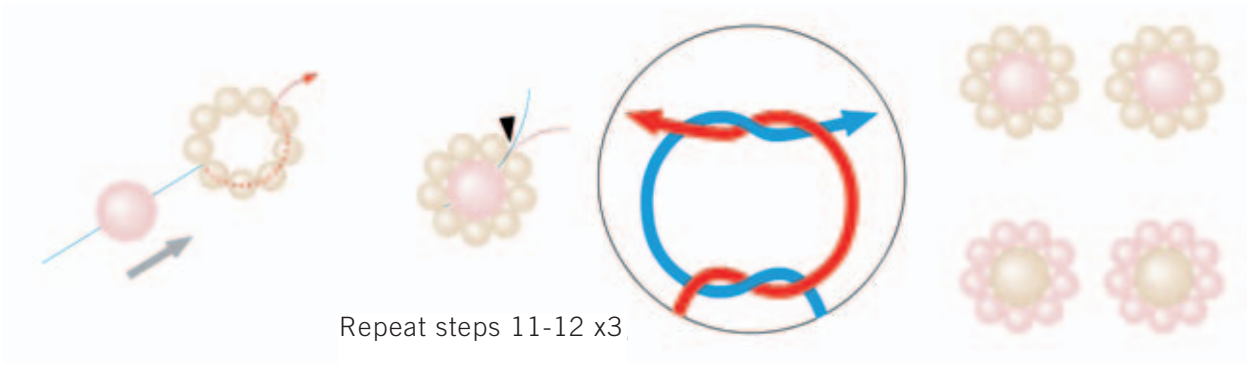

STEP 13

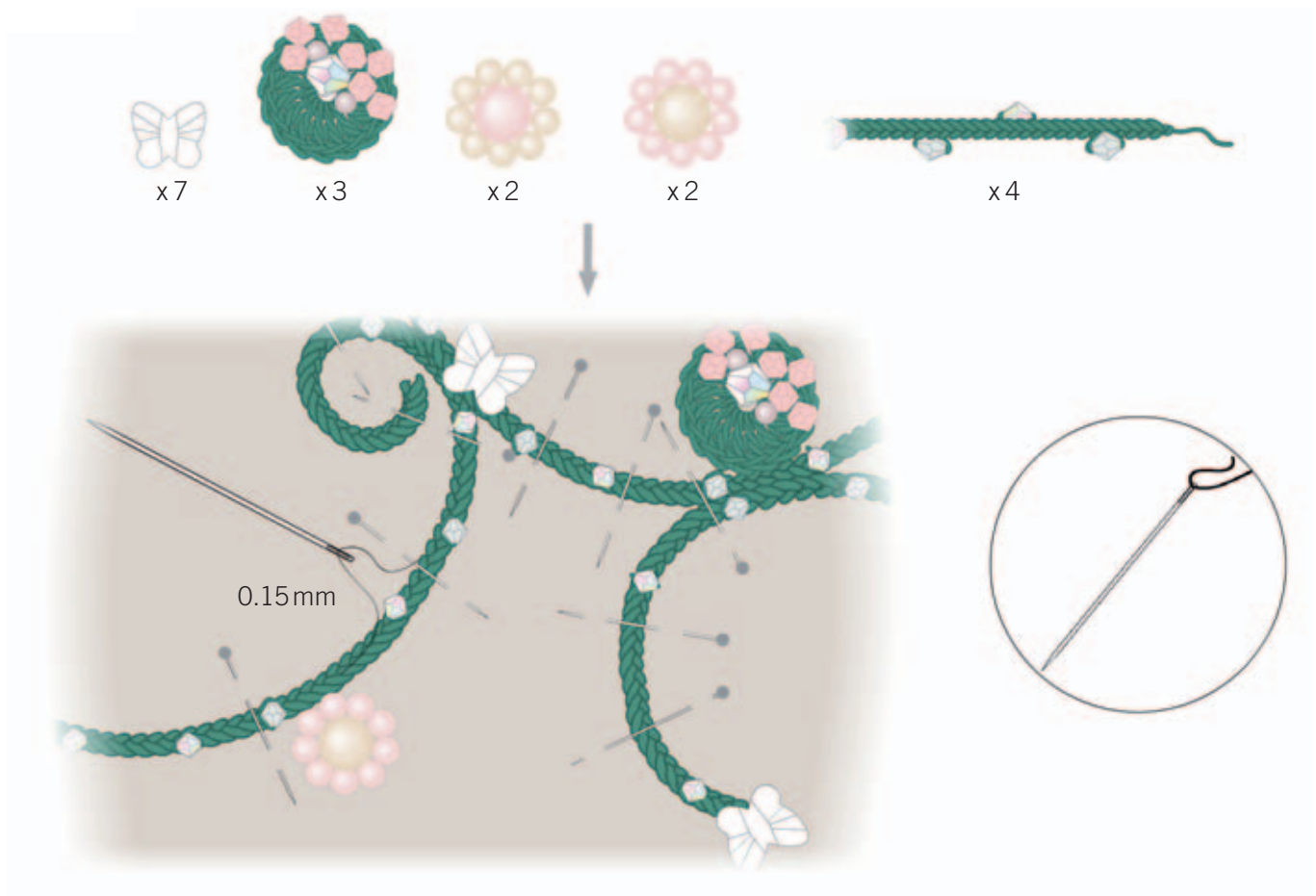

STEP 14



STEP 15

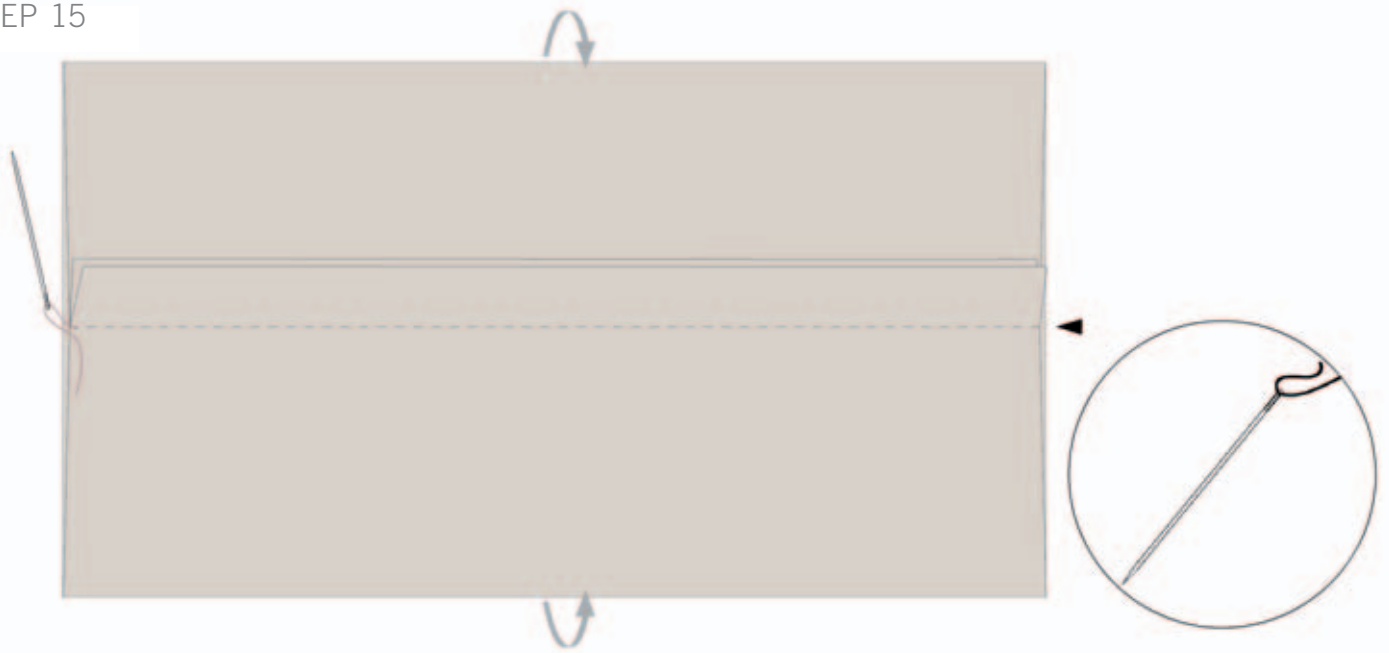

STEP 16

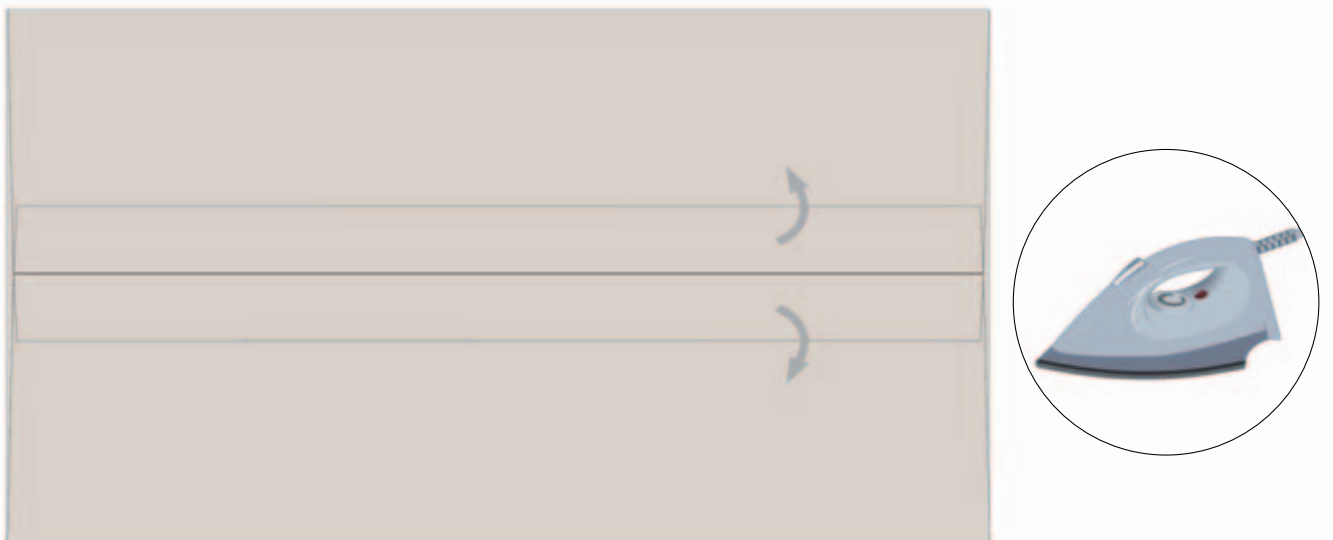

STEP 17



STEP 18

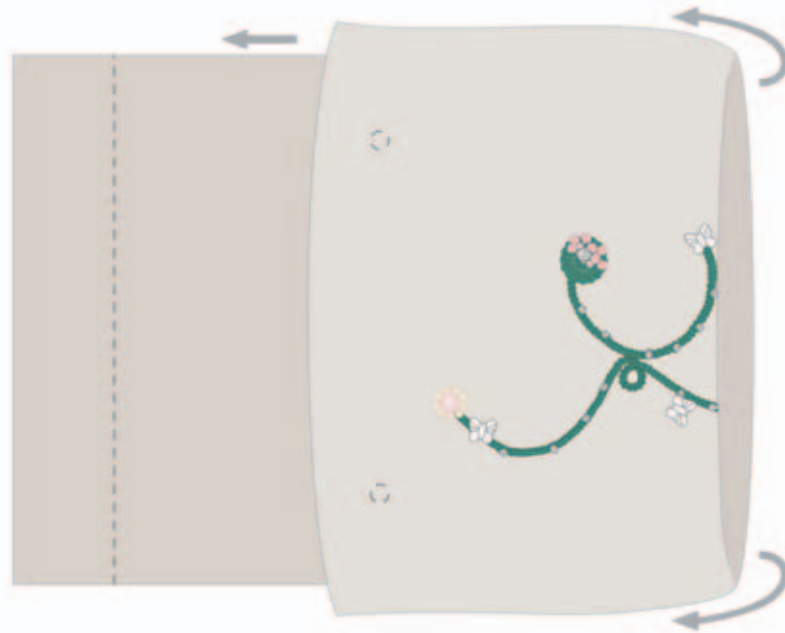

STEP 19



STEP 20

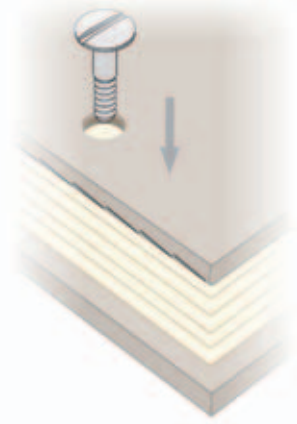

Scale 1:1

STEP 21

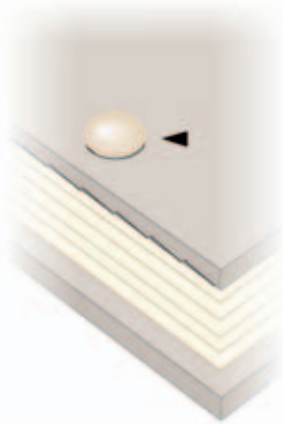

STEP 22

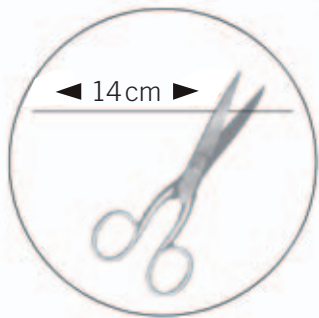

0.25mm

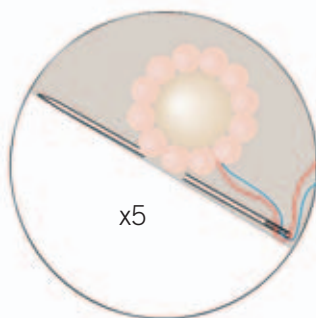
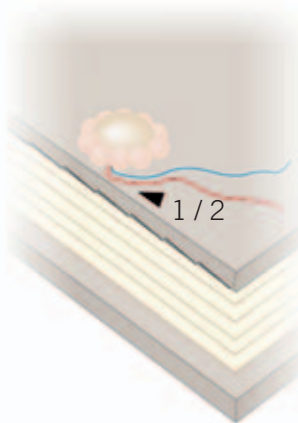
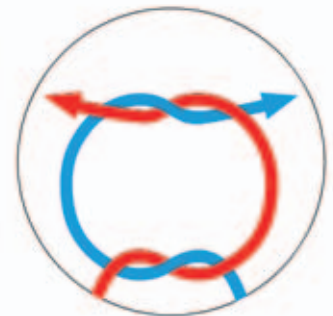
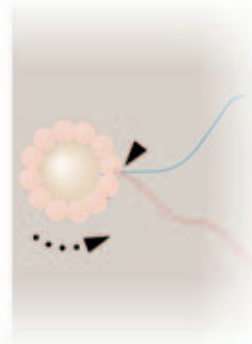

1



2

Repeat step 22 x1

Scale 1:3

STEP 23



Scale 1:2