

CREATE
YOUR STYLE
with SWAROVSKI ELEMENTS

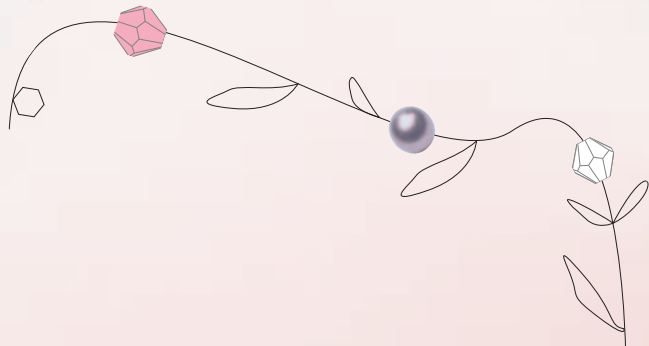

WEDDING COUNTRY BROOCH



WEDDING COUNTRY BROOCH



SWAROVSKI ELEMENTS

Article	Product Group	Article No.	Amount	Size	Color	Color Code
	Beads	5328	5 pcs.	3 mm	Violet Opal	389
	Beads	5328	1 pc.	5 mm	Violet	371
	Beads	5556	2 pcs.	11 x 19 mm	Crystal Silver Shade	001 SSHA
	Beads	5556	1 pc.	13.5 x 24 mm	Crystal Silver Shade	001 SSHA
	Crystal Pearls	5810	5 pcs.	10 mm	Crystal Mauve Pearl	001 160
	Crystal Pearls	5810	1 pc.	11 x 8 mm	Crystal Mauve Pearl	001 160
	Pendants	6090	1 pc.		Black Diamond	215
	Pendants	6744	1 pc.	12 mm	Crystal AB	001 AB
	Findings	47508	1 pc.	8 mm	Crystal Silver Shade	001 SSHA
	Filigrees	62003	1 pc.		Amethyst/ Light Amethyst	204/212

Supplies & Tools

Supplies

- Edged ribbon silver, 91 cm
- Filigree piece flower shaped for Brooch back, silver, small
- 2x Headpins, silver, 3.8 cm
- 2x Jumpings, silver, 6 mm
- 1x Pinback, silver, 1.9 cm
- Thread, grey, 23 cm
- Wire, silver, Ø0.4 mm, 112 cm
- Wire, silver, Ø1 mm, 30 cm

Tools

- Flat nose pliers
- Glue
- Round nose pliers
- Wire cutter

Level of design: ADVANCED

STEP 1

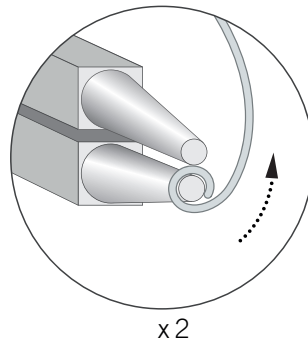
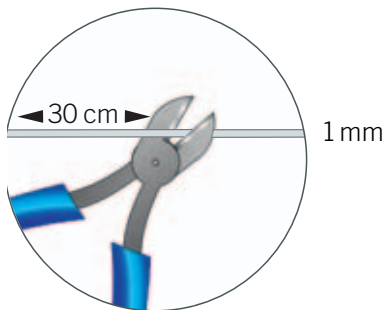

STEP 2

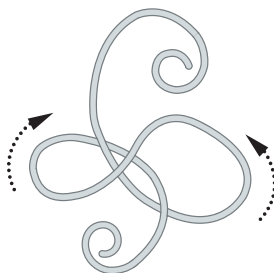

STEP 3

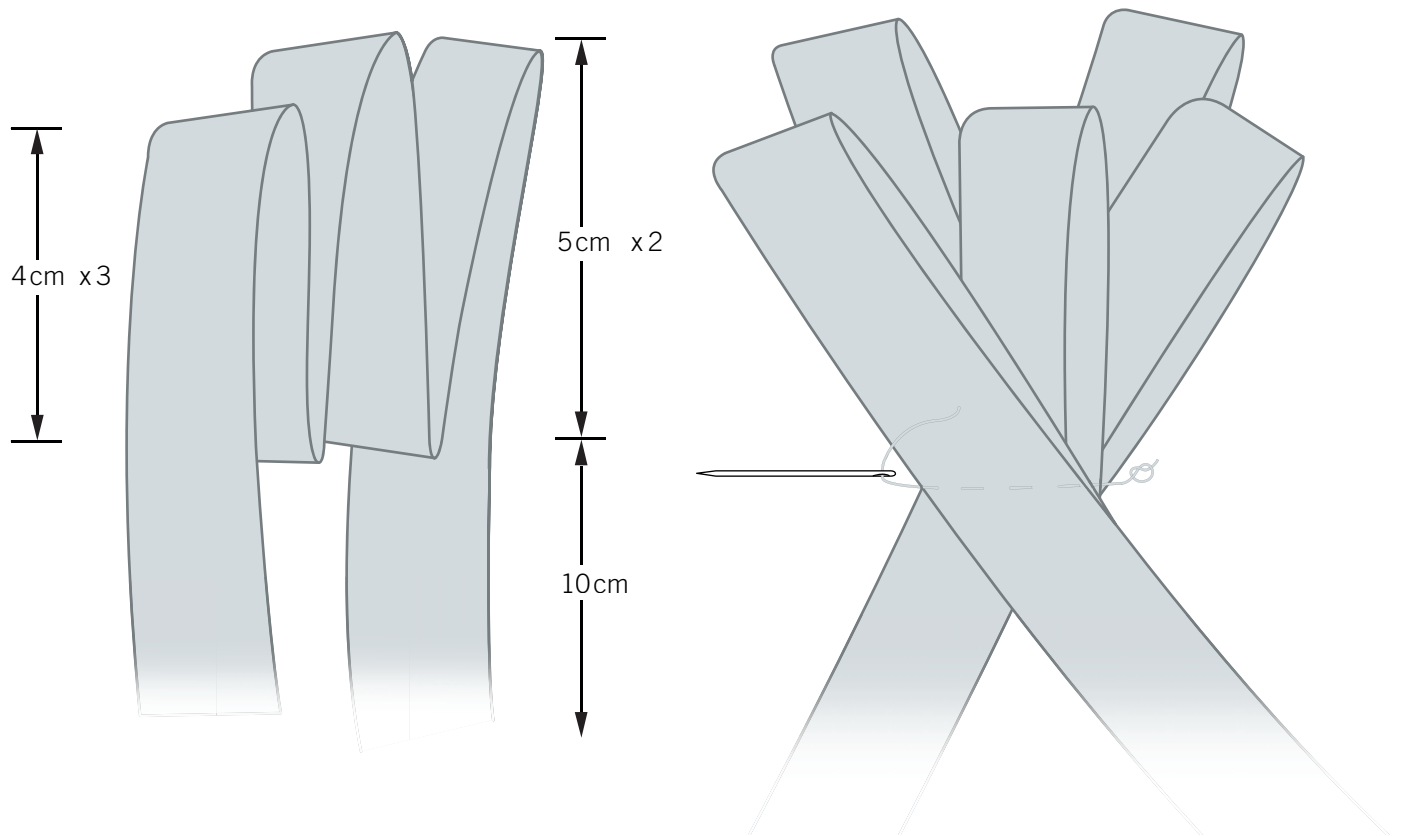

STEP 4

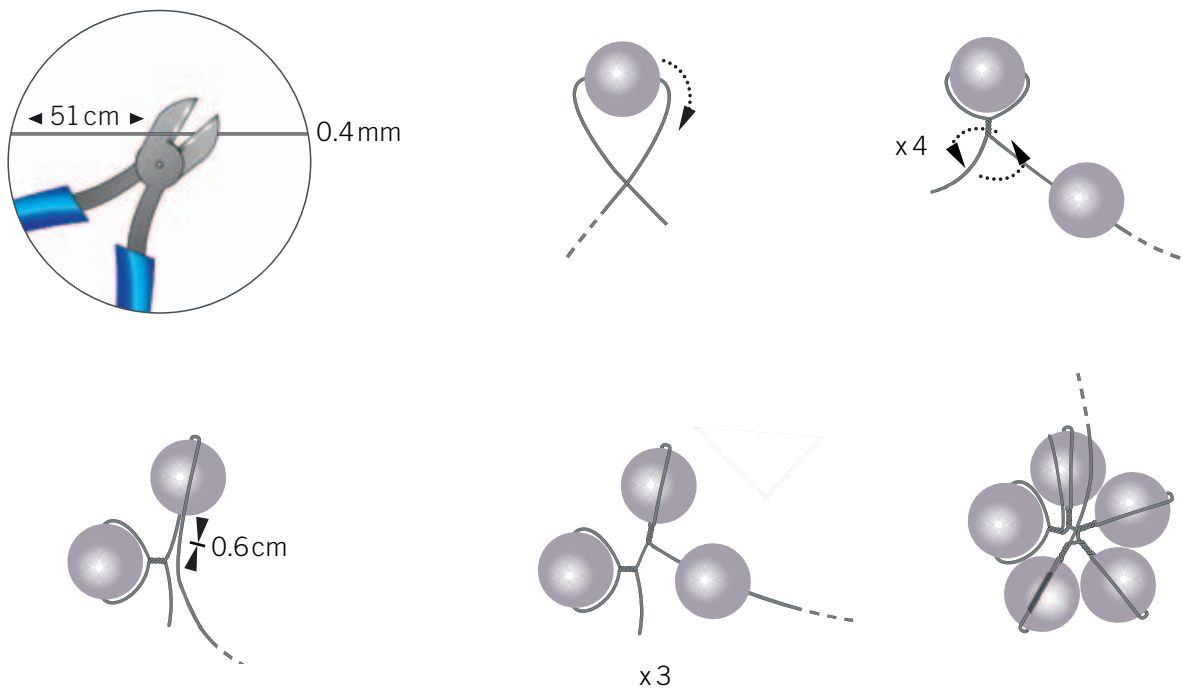

STEP 5

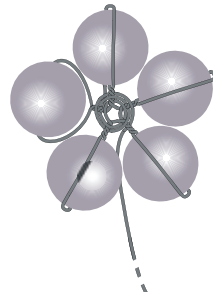
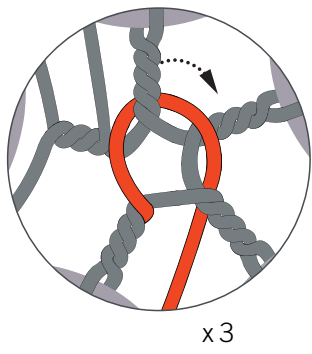

STEP 6

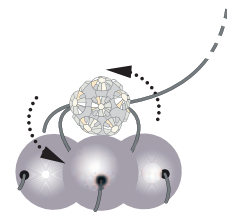
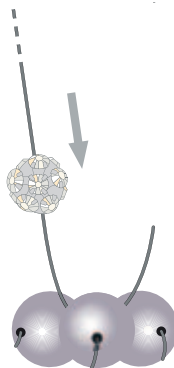
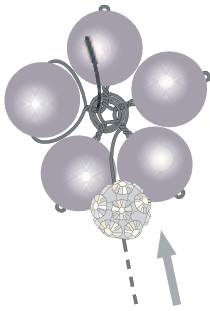

STEP 7

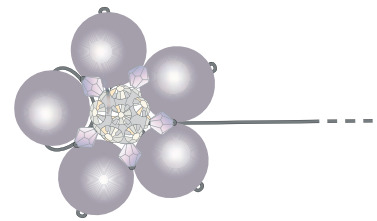
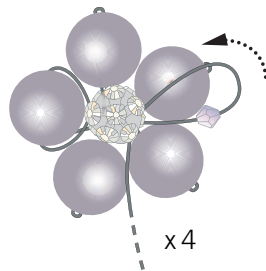
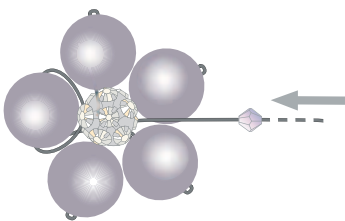

STEP 8

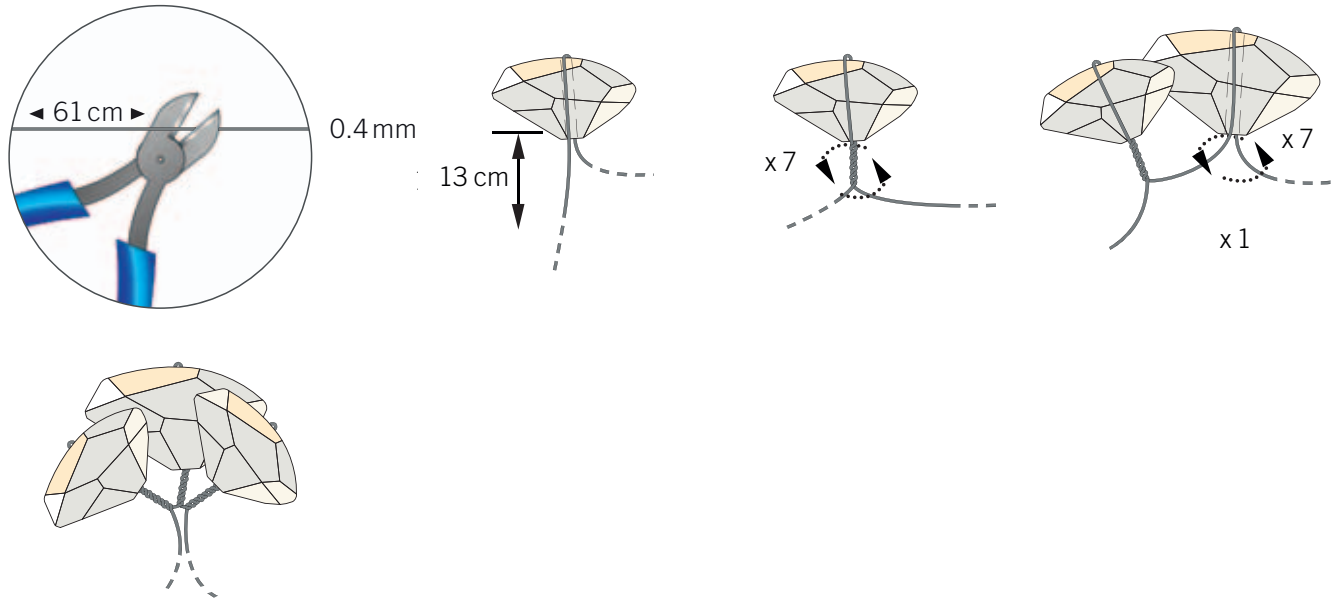

STEP 9

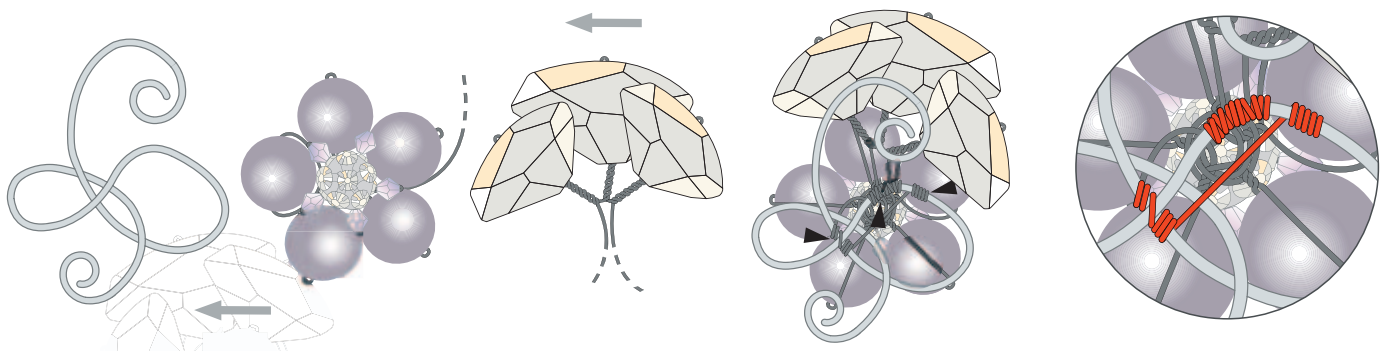

STEP 10

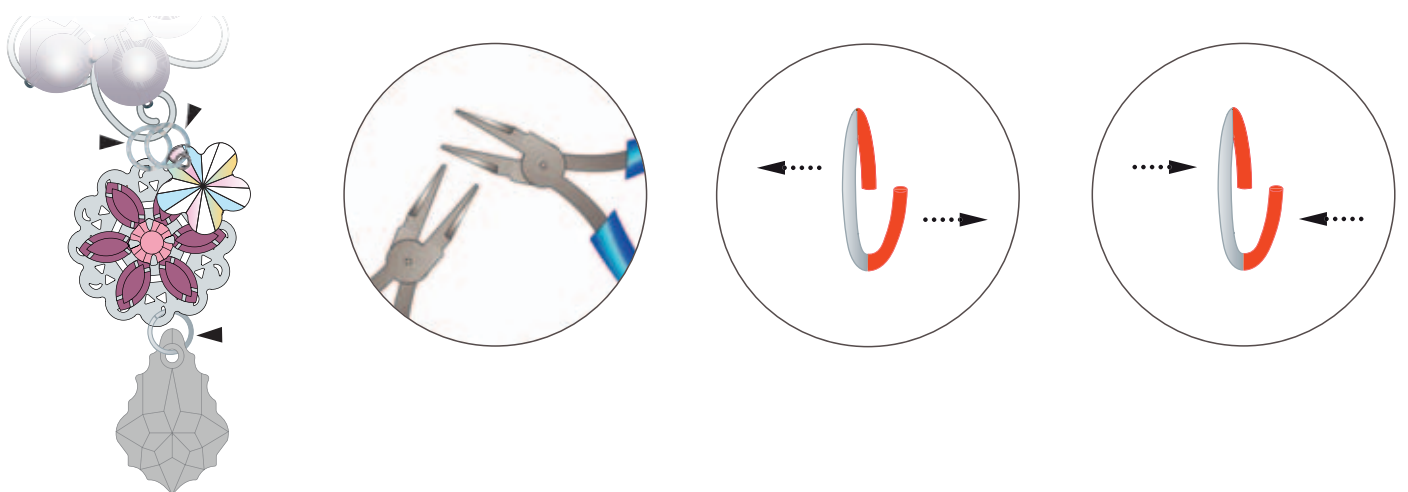

STEP 11

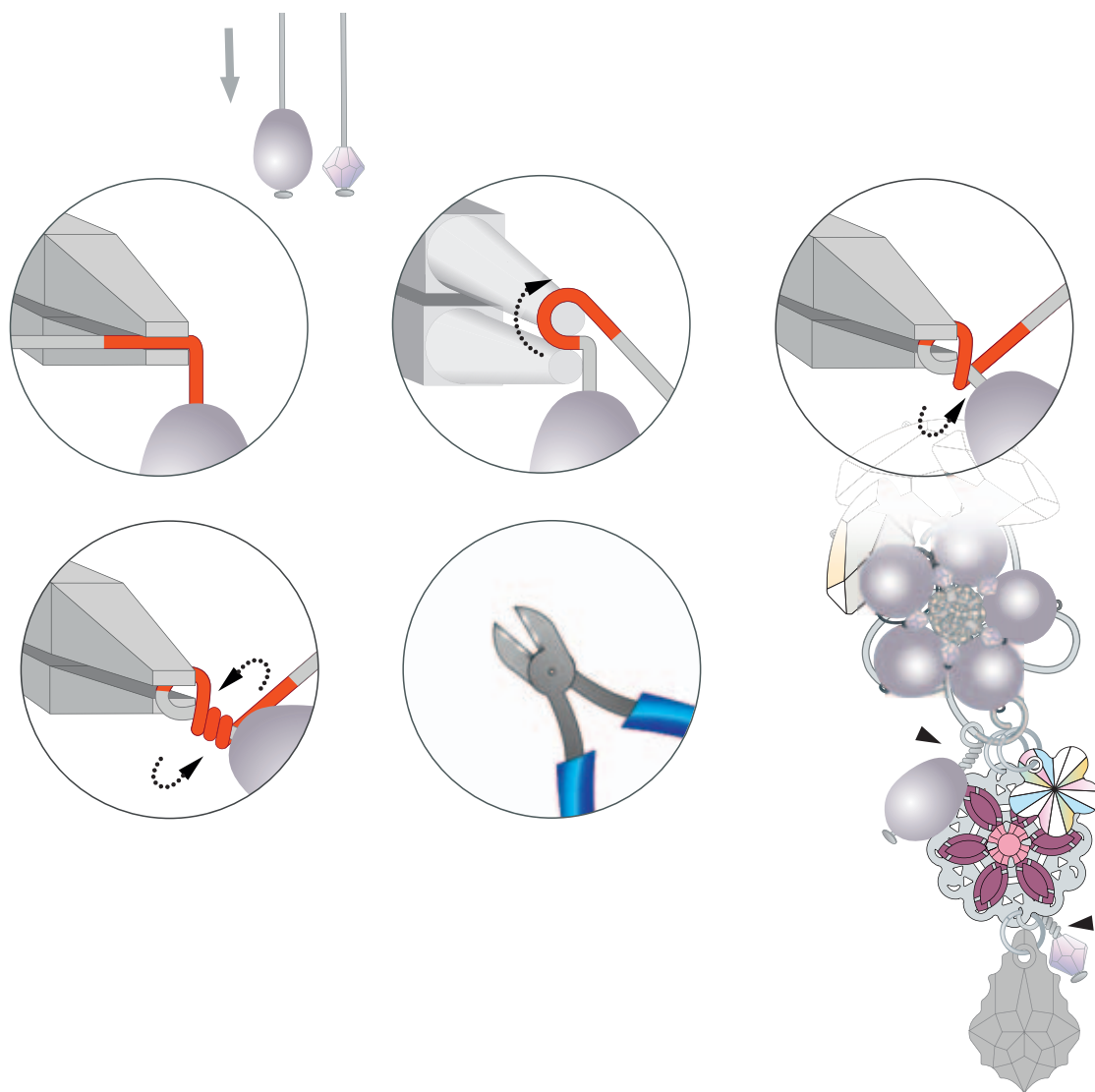

STEP 12

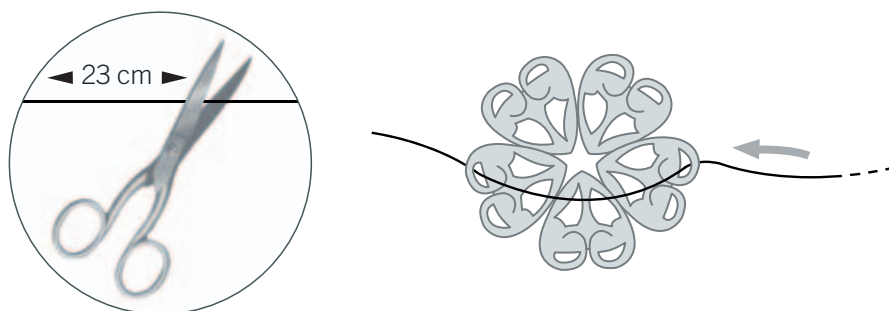

STEP 13

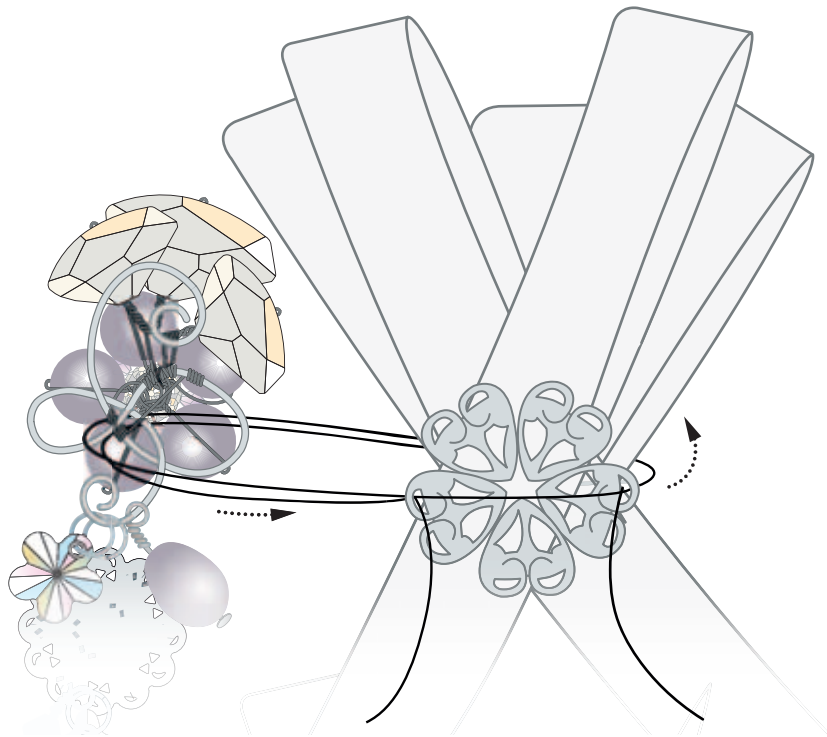

STEP 14

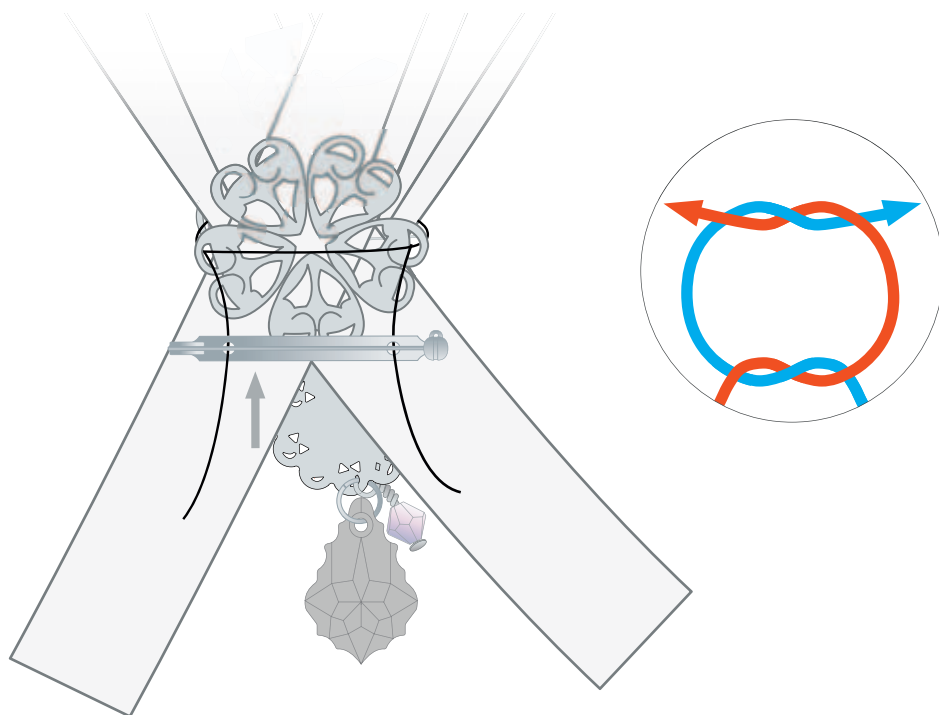

STEP 15

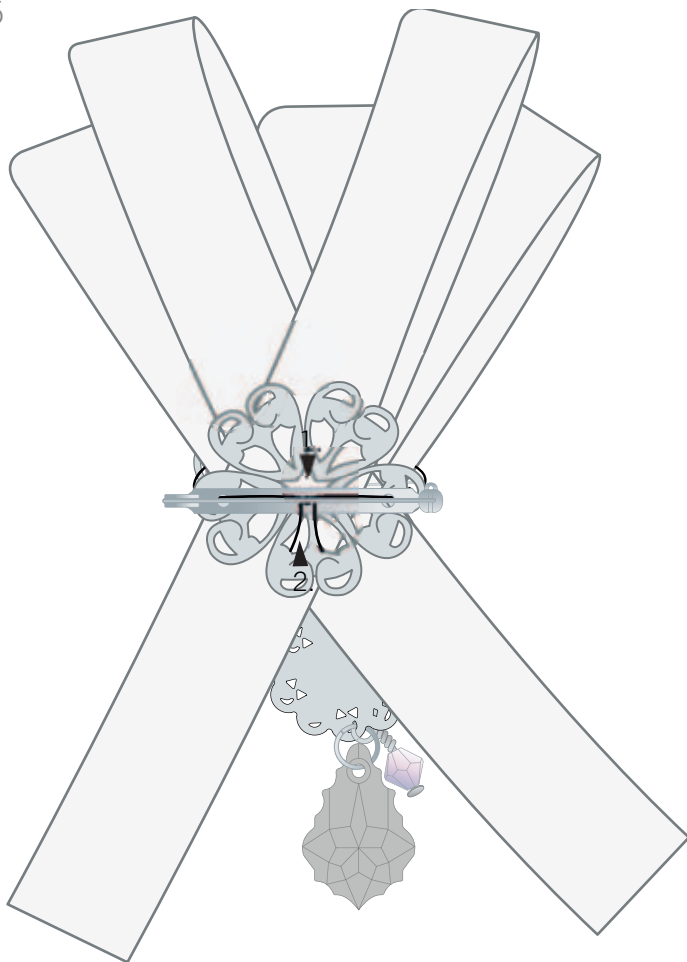

1.



2.

